

# A COMPLETE LINE OF INNOVATIVE PRODUCTS

**MOBILIS**  
ELITE

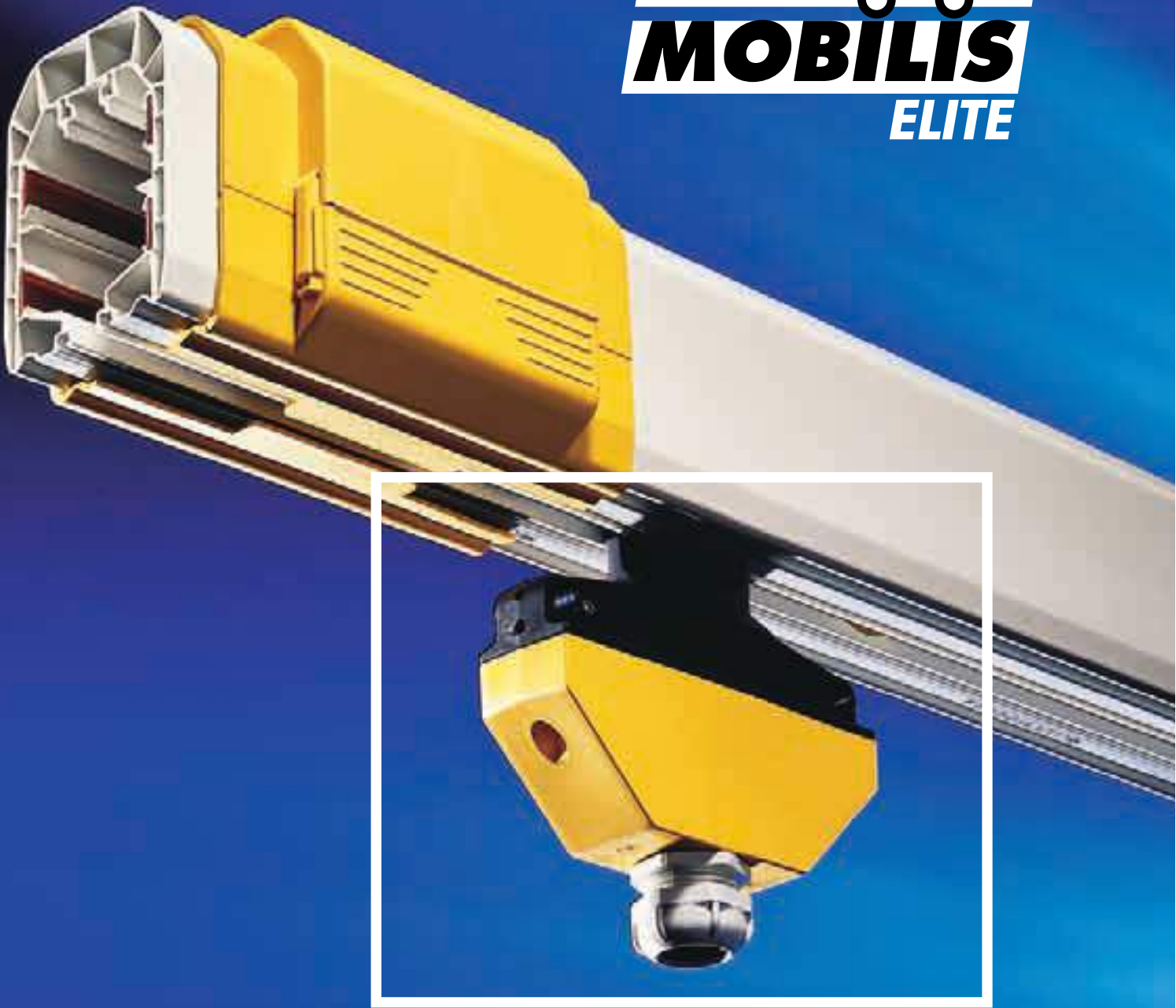

**ELECTRIFICATION OF TRAVELLING MACHINES**



## Manufacturers: performance and economy.

MOBILIS Elite has the advantage of high performance design without additional costs.

Thus giving manufacturers a competitive edge in development and marketing : more competitive assembling, maintenance and use.



## Installers : simplicity and flexibility.

Thanks to its limited number of parts, the systematic use of easily removed connections, and rapidly fitted accessories (without tools), MOBILIS Elite offers installers a system which is simple and quick to set up, whatever the location.



## Users : security and reliability.

As well as complying with standards and regulations in force, MOBILIS Elite stands out for its hard-wearing qualities and ease of maintenance, thanks to the use of tool-free fitting of accessories.



## Accessories quickly fitted and removed.

For easier fitting and maintenance, the main accessories have been designed for simpler, quicker, tool-free installation. The feeding box and covering flange are clipped on manually. However, they cannot be removed without the use of a tool, in accordance with regulations.



## Connection using removable self-breaking screw.

A patented principle of self-breaking screws allows controlled fixings with complete security and reliability. In addition, an improvement makes a later removal easier.

- During fitting of line elements, the self-breaking screw ensures optimum tightening torque for each fixing : once torque is achieved, the screw breaks.
- When the screw breaks, a second hexagonal end appears. This makes subsequent removal easier, using a simple key.

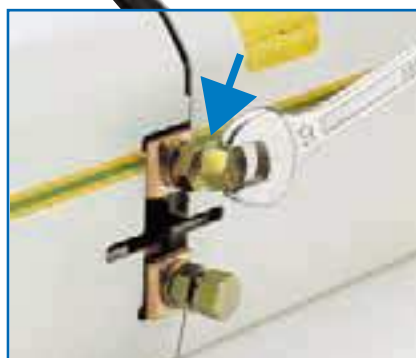

## Degree of protec- tion: choose high performance.

MOBILIS Elite makes the user's choice simpler by offering a complete range of accessories, all ensuring protection of the line against rain (IP23), thanks to an integrated watertight system.





# INNOVATION, SAFETY AND ECONOMY FROM 20 TO 200A

**Designed in co-operation with the Centre for the Plastics Industry in the Eastern France.**

For the PVC casing, FELS designed a profile that meets all the requirements of a demanding specification, within the framework of a PUMA procedure (Procedure for the Use of Advanced Materials), in co-operation with the Centre for the Plastics Industry in the Eastern France and the Ecole d'Application des Hauts Polymères (Advanced Polymer Applications School).

**Innovation is also aesthetic.**

MOBILIS Elite offers ergonomics without forgoing aesthetics. Elegant lines, harmonious colours, and coordinated elements result in a product which is both dynamic and smart, all combining to make this rail an aesthetically successful innovation.

**A range of temperatures for extended use.**

- -20°C to +55°C for usual applications
- -20°C to +75°C if required.

*FELS, specialists in electrical supply rails for over 30 years, has used its practical experience to good advantage. Its excellent knowledge of the specific demands of this type of product has enabled it to develop a new concept, full of technological innovation, both in terms of complying with regulations and in keeping with standardisation : MOBILIS Elite. This electrical supply rail meets all markets demands.*

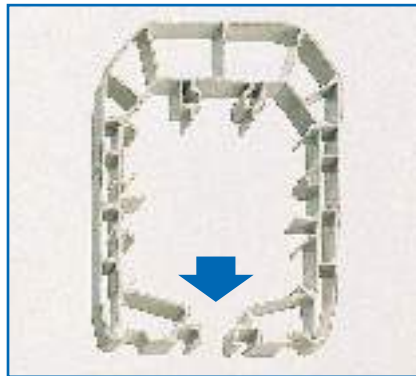

**Fels Mobilis, the originator of the cellular structure.**

Fels was the first to introduce optimised cellular structures for the Mobilis range, thus giving an excellent rigidity to the PVC profile. The casing is both light and strong and holds either 4 or 5 conductors. Its narrowed lower opening prevents any accidental contact with the inside.

**Removable Carbons: a MOBILIS Elite exclusive.**

MOBILIS Elite has taken maintenance into account from the design stage. So the carbons, the main elements subject to wear, are easily replaced without touching the carriage wiring. They are simply unclipped using a screwdriver.

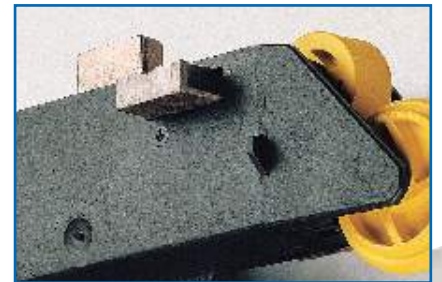

## OUTSTANDING ADVANTAGES.

- **Performance :**
  - extensive range (20 to 200A)
  - light, rigid PVC profile
  - long lines without expansion joint
  - permanent modularity...
- **Security :**
  - protection index IP23 according to EN60529
  - self-extinguishing materials
- **Fast assembling :**
  - pre-assembled product (connection screws, protection lips...)
  - clip-on accessories (tool-free installation)
  - connections through self breaking screws
- **Easy maintenance**
  - carbons removable
  - easy removal of connections
- **Modern design**

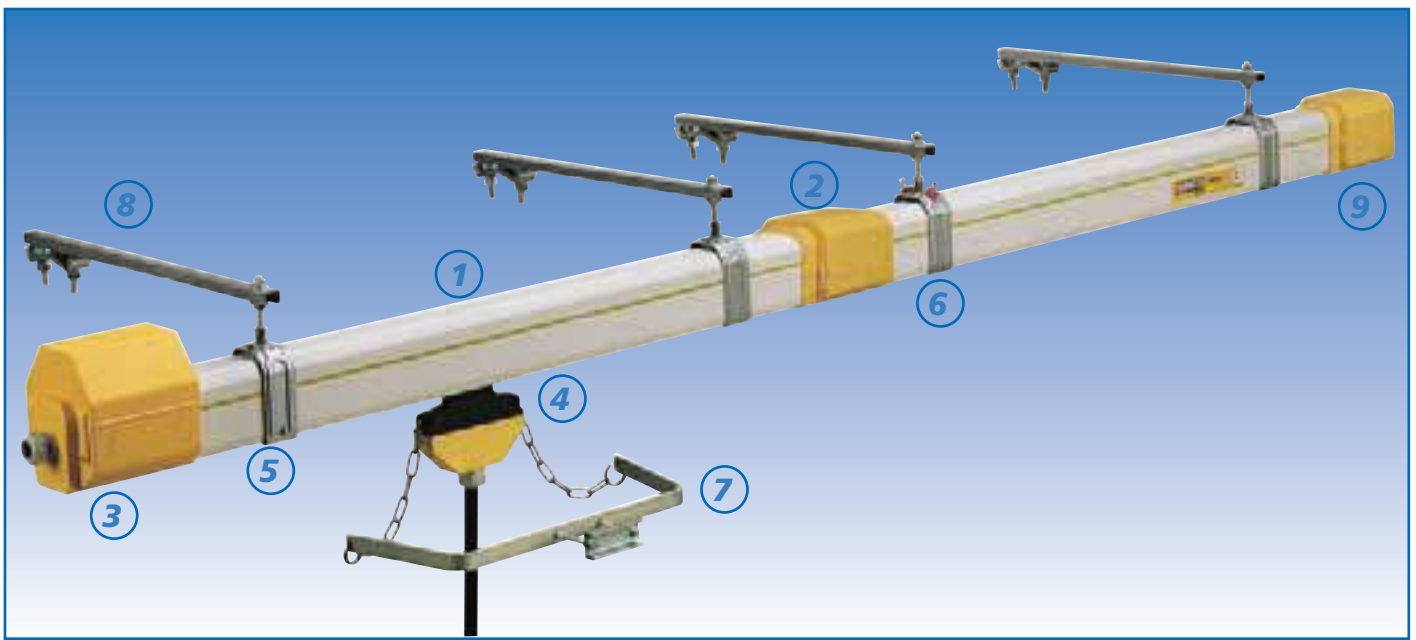

### 1 LINE ELEMENT



Self-extinguishing PVC  
Standard length 4m, 3m, 2m, 1m  
Special length on request  
Max. rated operational voltage : 750 V  
References hereunder

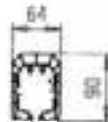

### EXPANSION JOINT

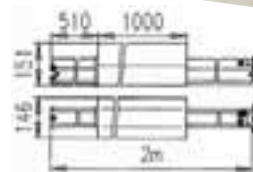

To install in the middle of lines longer than 140m, please enquire

IP23  
References hereunder

Intensity	20A		40A		60A		100A		130A		160A		200A TR	
Section L1, L2, L3, N	steel 16 mm <sup>2</sup>		copper 10 mm <sup>2</sup>		copper 16 mm <sup>2</sup>		copper 24 mm <sup>2</sup>		copper 35 mm <sup>2</sup>		copper 48 mm <sup>2</sup>		copper 70 mm <sup>2</sup>	
Section PE	steel 16 mm <sup>2</sup>		copper 10 mm <sup>2</sup>		copper 16 mm <sup>2</sup>		copper 24 mm <sup>2</sup>		copper 35 mm <sup>2</sup>		copper 24 mm <sup>2</sup>		copper 35 mm <sup>2</sup>	
Impedance 50Hz 35°C	0,0121 Ω/m		0,00178 Ω/m		0,00126 Ω/m		0,00081 Ω/m		0,00059 Ω/m		0,00043 Ω/m		0,00032 Ω/m	
Nb of poles	4	5	4	5	4	5	4	5	4	5	4	5	4	5
Weight (kg/m)	1,7	1,8	1,5	1,6	1,8	1,9	2,0	2,1	2,4	2,7	2,6	3,0	3,3	3,9
Length 4 m	ME4204	ME5204	ME4404	ME5404	ME4604	ME5604	ME4104	ME5104	ME4134	ME5134	ME4164	ME5164	ME8284-TR	ME8285-TR
Length 3 m	ME4203	ME5203	ME4403	ME5403	ME4603	ME5603	ME4103	ME5103	ME4133	ME5133	ME4163	ME5163	ME8283-TR	ME8289-TR
Length 2 m	ME4202	ME5202	ME4402	ME5402	ME4602	ME5602	ME4102	ME5102	ME4132	ME5132	ME4162	ME5162	ME8282-TR	ME8286-TR
Length 1 m	ME4201	ME5201	ME4401	ME5401	ME4601	ME5601	ME4101	ME5101	ME4131	ME5131	ME4161	ME5161	ME8281-TR	ME8287-TR
Special length	ME4200	ME5200	ME4400	ME5400	ME4600	ME5600	ME4100	ME5100	ME4130	ME5130	ME4160	ME5160	ME8280-TR	ME8288-TR
Expansion joint	ME8020	ME8520	ME8040	ME8540	ME8060	ME8560	ME8100	ME8510	ME8013	ME8513	ME8016	ME8516	ME8290-TR	ME8291-TR

### 3 END-LINE FEED BOX M25/M32/M40



Thermoplastic  
Self-extinguishing - IP 23  
Intensities 20, 40, 60, 100A  
Possibility PG outgoing down  
Collector trolley inaccessible zone : 35 mm  
Weight 0,4 kg

Please provide cable eye stiffeners Ø 5 for connection

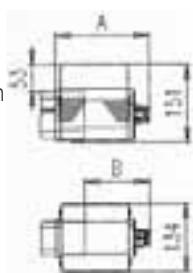

### IN-LINE FEED BOX M40

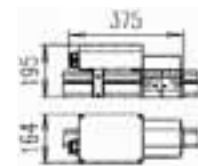

For the intensities 20, 40, 60 and 100A - IP23  
Cable ø 21 to 32 mm - Weight 1,5 kg  
References : (4P) ME1332 - (5P) ME1329

PE	Dimension A	Dimension B	References	cable ø
M25	181	126	ME 1200	13 to 19 mm
M32	183	128	ME 1230	15 to 25 mm
M40	186	132	ME 1250	21 to 32 mm

### IN-LINE FEED BOX M25/M32



Thermoplastic - Self-extinguishing - IP 23  
Intensities 20, 40, 60, 100A - Weight 0,3 kg  
Please provide cable eye stiffeners Ø 5 for connection

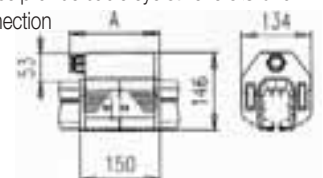

### 2 COVERING FLANGE

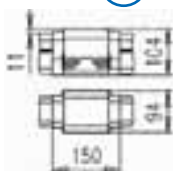

Thermoplastic  
Self-extinguishing  
IP 23  
Weight 0,2 kg  
Reference : ME1000

PE	Dimension	References	cable ø
M25	169	ME 1300	13 to 19 mm
M32	170	ME 1330	15 to 25 mm

# FEED BOX 130A, 160A AND 200A

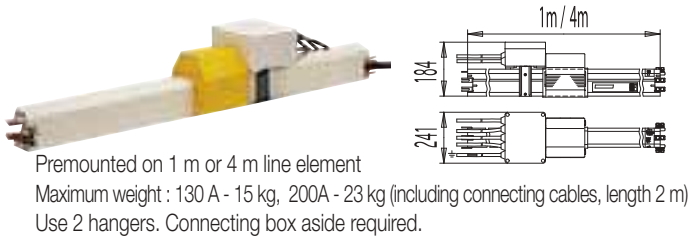

Premounted on 1 m or 4 m line element  
 Maximum weight : 130 A - 15 kg, 200A - 23 kg (including connecting cables, length 2 m)  
 Use 2 hangers. Connecting box aside required.

Intensity	Section	ø cable	Length	4 poles	5 poles
130A	35 mm <sup>2</sup>	16 mm	1 m	ME1313	ME1317
			4 m	ME1343	/
160A	50 mm <sup>2</sup>	18 mm	1 m	ME1316	ME1319
			4 m	ME1346	ME1349
200A TR	70 mm <sup>2</sup>	20,5 mm	1 m	ME8299-TR	ME8294-TR
			4 m	ME8279-TR	/

## 7 CARRIER



Fixing on a square bar 20 to 50 mm  
 Admissible clearance: horizontal +/- 50 mm; vertical +/- 50 mm

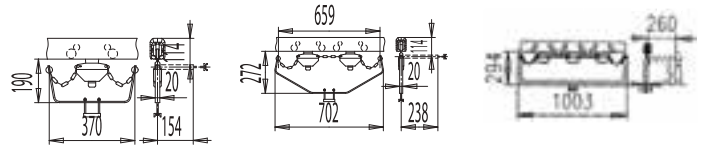

Simple carrier for simple trolley  
 Weight 0,6 kg  
 Reference : ME1600

Double carrier for double trolley  
 Weight 1,1 kg  
 Reference : ME1610

Triple carrier for triple trolley  
 Weight 2,6 kg  
 Reference : ME1630

## 4 SIMPLE TROLLEY



Self-extinguishing - Nom. Intensity 40A  
 Connection with a flexible cable  
 Terminal 6 mm<sup>2</sup> - Weight 0,6 kg

Références	Box	With cable
4 pôles	ME3043	ME2043
5 pôles	ME3051	ME2051

Références	Without cable	ME2034
With 1 m cable 4 mm <sup>2</sup>	ME2034-1M	
With 1 m cable 6 mm <sup>2</sup>	ME2036-1M	

4 poles only

## CARRIER WITH BOX

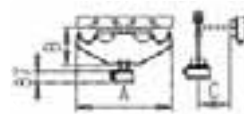

Simple : terminals 16 mm<sup>2</sup>  
 Double : terminals 25 mm<sup>2</sup>  
 Triple : terminals 25 mm<sup>2</sup> } cable ø : 22 to 30 mm

Type	References	FM 35° C	A	B	C	Weight
Simple	(4P) ME1660 (5P) ME1660	100%	370	194	154	1,4 kg
Double	(4P) ME1640 (5P) ME1645	61%	702	272	232	1,9 kg
Triple	(4P) ME1650 (5P) ME1655	40%	1003	294	260	3,4 kg

## DOUBLE TROLLEY



Nom. Intensity 80A  
 Connection with 2 flexible cables  
 Terminal 6 mm<sup>2</sup> - Weight 1,1 kg

Références	Box	With cable
4 pôles	ME4042	ME4047-1M
5 pôles	ME4050	ME4051

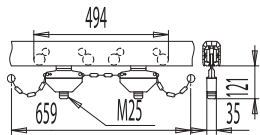

## 8 FIXING BRACKET

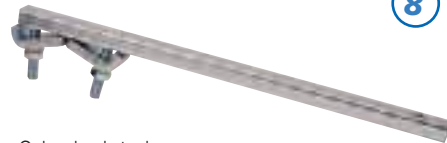

Galvanized steel  
 For intensity 200A, please only use ME1760 and ME1780

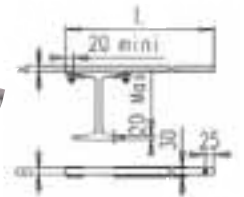

References	Length L	Section A x B	Weight
ME1700	380 mm	15 x 20 mm	0,5 kg
ME1750	500 mm	15 x 20 mm	0,6 kg
ME1760	600 mm	30 x 30 mm	1,0 kg
ME1780	850 mm	30 x 30 mm	1,2 kg

Please also enquire for our fast assembling clamped bracket reference ME1799



## TRIPLE TROLLEY

Nom. Intensity 120A  
 Connection through 3 flexible cables  
 Terminal 6 mm<sup>2</sup>  
 Weight 1,6 kg

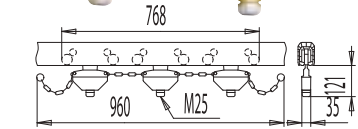

Références	Box	With cable
4 pôles	ME5040	ME5049-1M
5 pôles	ME5050	ME5059-1M

## 5 SLIDING HANGER



Galvanized steel  
 Screw M8 pre-mounted  
 2 pieces for a 4m element  
 Weight 0,1 kg  
 Reference : ME 1510

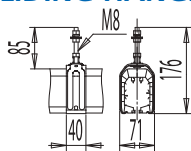

## 6 FIXED HANGER



Galvanized steel fully assembled  
 Delivered with 2 anchoring screws  
 Weight 0,1 kg  
 Reference : ME1500

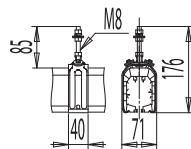

## 9 END CAP

Thermoplastic  
 Self-extinguishing - IP 23  
 Collector trolley inaccessible zone : 35 mm  
 Weight 0,3 kg  
 Reference : ME1400

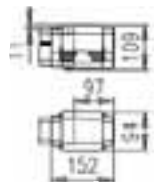

## SWITCHING FINGER



Galvanized steel fully pre-mounted  
 Rod length : 400 mm  
 Diameter 10 mm  
 Weight 0,570 kg  
 Reference : ME1550

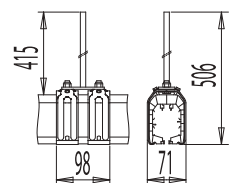

## OUR RANGE ALSO INCLUDES

- **Inlet gates**: enable the insertion or removal of collector trolleys for maintenance.
- **Curves**: available from 0,800 m minimum radius.
- **Protection lips**: flexible seals fitted to the running slot in the profile to prevent ingress of dust or moisture in harsh environments.
- **High speed trolleys**: for applications with speeds exceeding 100 mts/min.
- **Articulated trolleys**: for applications with curves.
- **Cleaning trolleys**: fitted with brushes to clean the conductors in harsh environments, or outside.
- **Ventilation elements** to avoid the condensation between a warm section and a cold section.
- Elements with **circuit interruption**.
- **Transfer elements** for switches.

## MOBILIS MOVIT® : ELECTRIFICATION LINE WITH SINGLE POLE CONDUCTOR RAILS 315A - 450A - 630A

As a leading specialist in electrical power supply, FELS is broadening its MOBILIS range with a highly innovative line of single-conductor rails boasting an unrivalled aesthetic quality.

Designed in the same spirit as the multi-pole conductor rail MOBILIS ELITE, MOBILIS MOVIT focuses on three key features :

- simplicity, in terms of transport, assembly, maintenance and dismantling ;
- safety, by taking into account installation and service conditions as well as respecting standards and regulations ;
- reliability, for optimum customer satisfaction.



FELS S.A. - 2, rue Joseph-Marie Jacquard - ZI Sud - BP 70069 - F67402 ILLKIRCH CEDEX  
Tel. +33 (0)3 88 67 10 60 - Fax. +33 (0)3 88 67 33 10  
www.fels.fr - E-mail fels@fels.fr

